

Bioinspired algorithms for optimizing the harmonics contents of a PWM power inverter

Algoritmos bioinspirados para optimizar el contenido de armónicos de un inversor de potencia PWM

Jorge L. Díaz-Rodríguez¹,
Oscar E. Gualdrón-Guerrero² y Aldo Pardo-García³

Recibido: 27 de mayo de 2014,
Aceptado: 21 de octubre de 2014

Cómo citar / How to cite

J. L. Díaz-Rodríguez, O. E. Gualdrón-Guerrero y A. Pardo-García, "Bioinspired Algorithms for optimizing the harmonics contents of a PWM Power Inverter", *Tecno Lógicas*, vol. 18, no. 34, pp. 63-74, 2015.

© Copyright 2015 por
autores y Tecno Lógicas
Este trabajo está licenciado bajo una
Licencia Internacional Creative
Commons Atribución (CC BY)



-
- 1 Master in Science in Automatic Control, Dept. Electrical and Computer Engineering, University of Pamplona, Pamplona-Colombia, jdiazcu@gmail.com
 - 2 Ph.D. Electronic Engineering, Dept. Electrical and Computer Engineering, University of Pamplona, Pamplona-Colombia, oscar.gualdrón@unipamplona.edu.co
 - 3 Ph.D. Electric Engineering, Dept. Electrical and Computer Engineering, University of Pamplona, Pamplona-Colombia, apardo13@hotmail.com

Abstract

This paper deals with the evaluation of different bio-inspired algorithms techniques for reduction of harmonic distortion (THD) in pulse width modulation (PWM) of power inverters. A comprehensive study is performed, that identifies and develops biologically inspired optimization algorithms based mainly on tabu search, genetic algorithms (GA), particle swarm optimization (PSO), and ant colony optimization (ACO). These bio-inspired optimization methods were used to find the best operational parameters of a PWM applied to a power inverter. The best results were achieved when the pulse position is near to the middle position ($P_p=0.5$) or symmetry of the pulse. For the four methods analyzed the best result was obtained using ACO method based on the lowest THD content and less 5th and 7th harmonics magnitude with fewer pulses ($N_p=38$), almost 5 times lower than the result of PSO ($N_p=179$). It was achieved to reduce losses considerably with a reduction in the switching frequency of the power devices (4560 Hz). The algorithms developed can be easily adapted to any minimization problem, only making changes in the number of variables and selection (or elimination) criteria to obtain better results in complex problems.

Keywords

Pulse width modulation, tabu search, genetic algorithm, ant colony optimization, particle swarm optimization.

Resumen

Este trabajo se centra en la evaluación de diferentes técnicas de algoritmos bio-inspirados, que permitan reducir la distorsión armónica (THD) de la modulación de ancho de pulso (PWM) en inversores de potencia. Se realizó un amplio estudio que identifica y desarrolla algoritmos de optimización de inspiración biológica basados principalmente en la búsqueda tabú, algoritmos genéticos, optimización por enjambre de partículas y colonia de hormigas. Los métodos de optimización bio-inspirados son usados principalmente para encontrar los mejores parámetros operacionales de un PWM aplicado a inversores de potencia. Los mejores resultados fueron obtenidos cuando la posición de pulso (P_p) se localiza cerca a la posición central ($P_p=0.5$) o a la simetría del pulso. Dentro de los cuatro métodos estudiados el mejor resultado se encontró usando la técnica de optimización por colonia de hormigas, debido al valor de THD más bajo encontrado e igualmente con el 5 y 7 armónico con menos impulsos ($N_p= 38$), casi 5 veces menor que el resultado usando la técnica optimización por enjambre de partículas, logrando reducir considerablemente las pérdidas bajando la frecuencia de conmutación (4560 Hz) de los dispositivos de potencia. Los algoritmos desarrollados pueden fácilmente adaptarse a cualquier problema de optimización, solo haciendo cambios en el número de variables y en la selección (o eliminación) de los criterios y así de esta manera obtener mejores resultados en problemas complejos.

Palabras clave

Modulación por ancho de pulso, búsqueda tabú, algoritmos genéticos, optimización colonia de hormigas, optimización por enjambre de partículas.

1. INTRODUCTION

The use of Pulse Width Modulation (PWM) techniques in the control of electrical machines generates harmonics that produce heat and braking torques that cause energy losses, less efficiency and a reduced lifetime. To solve this problem, is required to determine optimal adjustment parameters of the PWM [1].

Biologically inspired optimization techniques are very useful when in necessary to solve complex problems using computer algorithms. Without establishing any mathematical classical optimization, the optimization problem can be solved numerically, finding optimal values [2], to find the suitable parameters to reduce the harmonic distortion (THD) in a PWM inverter.

In specialized literature can be found the application of genetic algorithms to optimize the PWM modulation, in the early work is that of Shi and Li [3]. In the above paper, a genetic algorithm is applied to optimize a PWM power inverter, with sinusoidal PWM (SPWM) and random PWM. However, both modulations do not constitute an appropriate starting point; it can be, added other parameters such as triangular asymmetry or use other PWM technique to ensure lower harmonic distortion content as the direct method PWM [4]. Others harmonic optimization criteria, beside THD, can also be used minimization or fitness as the 5th and 7th harmonics magnitude, which are the most representative of lower order produced by the inverter, because the 3rd order harmonic are suppressed with a properly motor connection.

1.1 Direct Method PWM

The main advantage of using the direct PWM method is not dependent on classical comparison of a sinusoidal modulating signal with a triangular carrier signal as in the case of PWM sinusoidal modulation

(SPWM). The direct method PWM algorithm generates switching angles (pulses positions) that are determined using numerical methods by reproducing a pulse shaped waveform patterns with the equivalent area of a sinusoid, thus maintaining the same root mean square (RMS) voltage.

1.1.1 Direct method PWM Simulation

The direct method PWM is developed using Simulink[®], with the Inverter - Direct Method PWM block that generates the PWM with a phase shift of 120 degrees (three phase). The block has the following inputs: frequency (f), amplitude (V), number of pulses (Np) and pulse position (Pp). Fig. 1 shows the PWM simulation model and the computation of the harmonic content (THD) including the 5th and 7th harmonics and it relation to the fundamental component (1st harmonic).

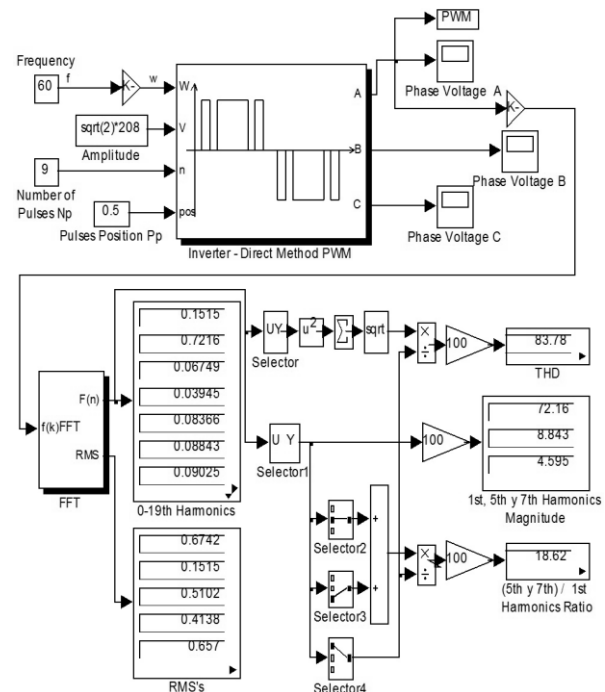

Fig. 1. PWM system simulation model. Source: Authors

Fig. 2a shows the output PWM voltage, with a frequency of $f=60$ Hz, nine pulses per half cycle ($N_p=9$) and a pulse position of $P_p=0.5$. Fig. 2b shows the harmonics spectrum of the previous signal.

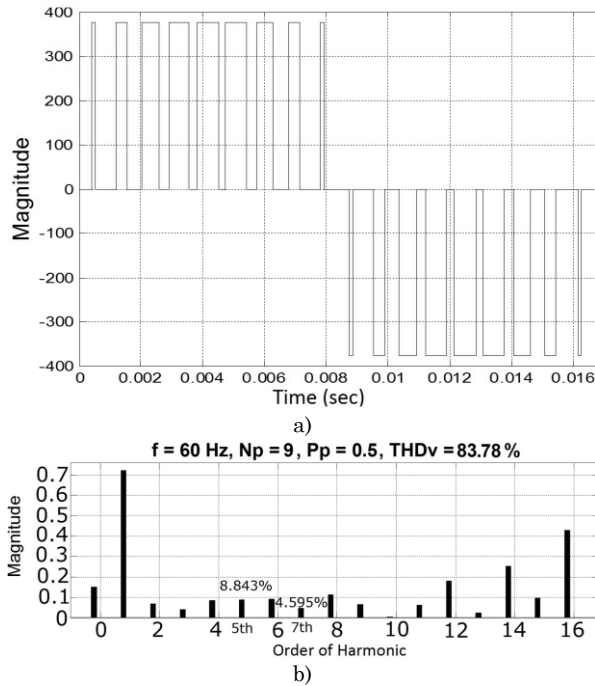

Fig. 2. Direct Method PWM. a) Phase voltage, b) Harmonic spectrum. Source: Authors

Fig. 1 shows that the magnitudes of the fundamental voltage harmonic (1st harmonic) of 72.16%, the low order harmonics have the highest magnitude, in the first 20 harmonics with a THD_v of 83.78%, the magnitude of the 5th is 8.843% and the magnitude of the 7th harmonics is 4.595%.

2. OPTIMIZATION METHODS

The parameters number of pulses (N_p) and pulse position (P_p) were selected as the PWM parameters to be optimize, it will result in combinations of these parameters that provide the highest performance (low THD) of the PWM power inverter.

2.1 Tabu Search

The tabu search (TS) is an optimization method which increases the performance of local search method by using memory structures to store combinations (or set of solutions) that have already been tested, thus eliminating the possibility of revisiting repeatedly that solution [5]. Fig. 3

shows the tabu search flowchart implemented.

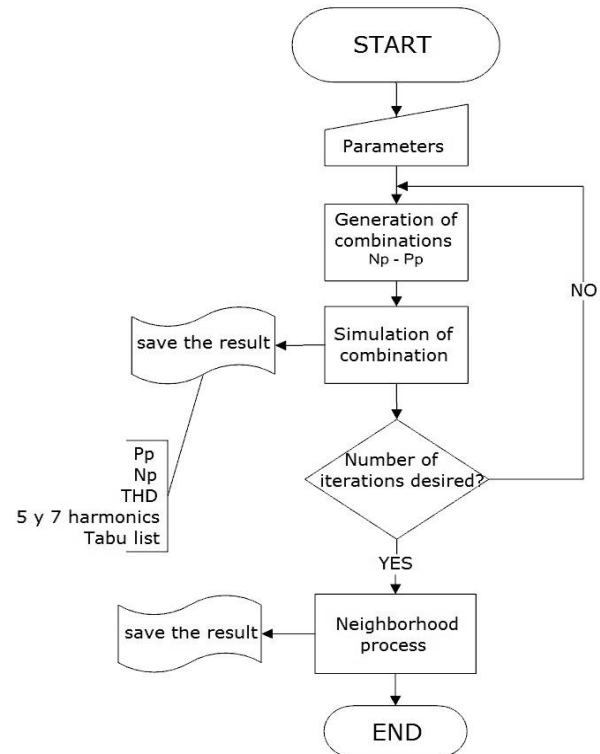

Fig. 3. Tabu search flowchart. Source: Authors

In addition to the simulation solutions a local search function is generated and it is called neighborhood, which plays a decisive role when optimizing the values of the best combinations.

2.2 Generation of N_p and P_p combinations

Combinations of N_p and P_p are generated randomly, dividing the pulse position (P_p) vector by 1000 (0 to 1.000), and establishing 1000 possible values. In the end it is verified that the obtained values are not in the tabu list of the solution values that have been tested in previous simulations.

2.3 Simulation of the combinations

The combinations vectors are obtained by introducing in the model different values of N_p and P_p . Once simulated, the algorithm returns the THD_v and the magnitudes of 5th and 7th harmonic (values are

stored). Also is added to the list the Np and Pp combinations that were used. Each time that new values are generated from the vectors Np and Pp are compared with the tabu list to ensure they are different to any previous value.

2.4 Neighborhood process

The neighborhood process store combinations that meet the conditions and which are obtained with an array of suitable data for the optimization process: THDv less than 20% and the sum of 5th and 7th harmonics magnitudes should be inferior to 9%.

2.5 Tabu search results

The neighborhood function is applied to the results matrix, this code find the neighborhood of the pairs of data resulting from the tabu search using as a parameter tuning the THD and the sum of the magnitudes of the 5th and 7th harmonics. Simulation of 20 pairs of Pp and Np are shown in Table 1:

Table 1. Parameters that satisfy the condition. Source: Authors

Number of pulses [Np]	Pulse position [Pp]	Sum of the 5 th and 7 th harmonics	%THDv (first 20 harmonics)
13	0.341	1.37290427	6.97362064
31	0.762	4.99990268	10.9149762
94	0.403	4.64422036	7.25181414
109	0.675	8.76354474	15.6896592
126	0.552	3.59494738	13.8393199
31	0.308	3.39887282	8.66580647
71	0.966	6.48393445	19.4835136
57	0.706	1.98611406	18.7480332
93	0.597	1.82245912	7.67658811
144	0.582	4.3136683	7.65579058
12	0.100	4.85852735	13.9330217
134	0.167	5.11391846	13.897079
30	0.147	6.55169061	12.6359197
34	0.672	5.15773339	13.0042188

Table 2 shows the simulation results where 15 values were found, using the above characteristics which were used in the neighborhood process, doing a local search for the values close to Np and Pp storing the best THDv results combinations and the sum of the magnitudes of 5th and 7th harmonics.

Table 2. Neighborhood local search results. Source: Authors

Number of pulses [Np]	Pulse position [Pp]	%5 th and 7 th harmonics	%THDv 20 harmonics	Decrease %5 th and 7 th harmonics	Decrease %THDv 20 harmonics
13	0.341	1.37290427	6.97362064	0	0
30	0.562	4.99990268	10.9149762	2.99012065	3.87404696
93	0.503	4.64422036	7.25181414	3.96530197	-0.28220706
106	0.675	8.76354474	15.6896592	7.92821873	8.37060139
127	0.652	3.59494738	13.8393199	1.8192034	2.56622449
30	0.308	3.39887282	8.66580647	2.11823627	2.90197721
69	0.866	6.48393445	19.4835136	3.42769507	6.35277023
57	0.706	1.98611406	18.7480332	0	0
93	0.497	1.82245912	7.67658811	1.14354073	0.14256691
145	0.682	4.3136683	7.65579058	3.21365433	-0.55997317
12	0.500	4.85852735	13.9330217	4.08637911	7.13855937
135	0.167	5.11391846	13.897079	1.97086399	3.76181006
26	0.247	6.55169061	12.6359197	5.4047603	2.70319885
35	0.572	5.15773339	13.0042188	3.3726667	4.18686448

The last 2 columns shows improvements made to the selected parameters (using neighborhood), positive values mean features improvement (harmonic reduction) and negative values mean features deterioration. The lower THD_v of the first 20 harmonics at the output of the neighborhood process is 5.76%, the signal harmonic spectrum is shown in Fig. 4.

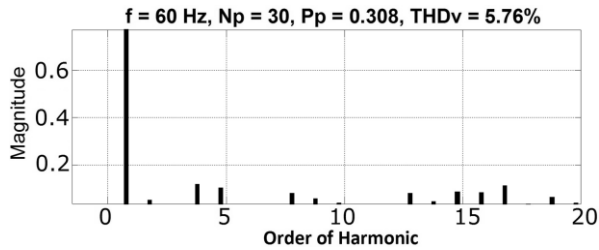

Fig. 4. Harmonic spectrum (60 Hz). First 20 harmonics. Source: Authors.

2.6 Genetic algorithm

The genetic algorithm (GA) developed is a real-coded genetic algorithm (RCGA), in which the individuals chromosomes are not coded in binary, but in real values [6]. Fig. 5 shows the flowchart of genetic algorithm used.

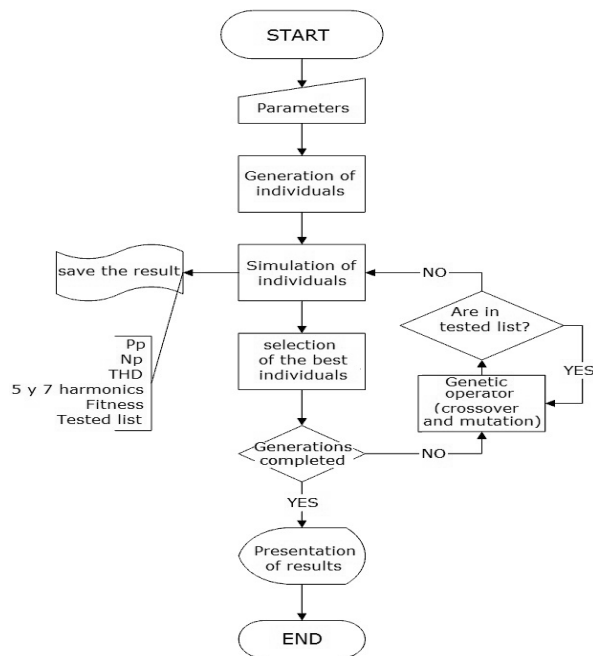

Fig. 5. Genetic algorithm flowchart. Source: Authors

The chromosomes used to characterize our individuals are Np, Pp, fitness, THD, 5th and 7th harmonic values. In addition to the characteristics of the GA a list has added to store the combination of previously simulated chromosomes from being selected and repeatedly have been the result of genetic operators crossover and mutation, thus the runtime code it reduced.

2.7 Individuals generation

For the population process generation a function with 3 operation modes was developed: *Mode=1*: generate the initial population, *Mode=2*: generates population different to the tested combinations list, and *Mode=3*: generates population different to the tested combinations list, as the best individuals from the previous generation. Individuals are stored in an equal number to the population that has been chosen; the Np and Pp values are different from each pair.

2.8 Individuals simulation

For the individuals' simulation they traverse the structure in which each pair of chromosomes are stored and evaluated. In each individual the simulation results can be stored.

2.9 Selection of the best individuals

For the selection of the best individuals the following objective (fitness) function was used (1):

$$F_{fitness} = \frac{thd(5^{th} + 7^{th})harmonics}{\sum_{k=1}^{population} thd(5^{th} + 7^{th})_k harmonics} \quad (1)$$

The objective function is set to minimize the lower order odd harmonics, the most significant ones, because the desired sine PWM waveform should not have any even harmonics. The connection terminals of the machine in delta or isolated star eliminate the third harmonic and its mul-

tiples. As the 5th and 7th harmonics are the heaviest and therefore those who want to minimize. Individuals are chosen to be crossed or mutated comparing the results according to the Ffitness function. The best individuals are stored in a file (best_indi).

2.10 Crossover and mutation

Once the population was simulated a function (func_best) is invoked, built to get from individuals the desired characteristics. The crossover is made between individuals contained in the previous file (best_indi), if the number of selected individuals does not provide the number of chromosomes (data) necessary to generate the population required, the remaining are generated with the mutation operator, multiplying the Np and Pp chromosomes by a mutation factor. The total numbers of individuals created in each generation are different from all previously tested.

2.11 Genetic algorithm results

The first generation is found in the first 4 columns of the Table 3. The second generation (last 4 columns) was generated for population reproduction, when crossovers cannot be made; we proceed to mutation or random generation of new individuals. The second generation comes from simulation results of the previous selected chromosomes.

The second generation corresponds to the crossing of the best chromosomes in the first generation, is also taken into account the random generation to complete the desired length of individuals [7]-[9]. The crossover of two chromosomes of the first generation led to generate an individual with excellent condition, the one with THD_v=4.1% corresponding to values of Np=38 and Pp=0.5320. The frequency magnitude spectrum at 60 Hz is presented in Fig. 6.

Table 3. First generation and second generation chromosomes. Source: Authors

First generation				Second generation			
Np	Pp	% 5th y 7th harmonics	%THD _v	Np	Pp	% 5th y 7th harmonics	%THD _v
117	0.5320	1.347	9.3319	117	0.6850	5.405	9.3804
43	0.6320	2.908	12.4331	68	0.3970	6.486	8.931
45	0.1350	3.087	12.9489	138	0.6230	2.442	9.6461
41	0.1430	6.900	21.6559	17	0.7040	3.942	7.7214
50	0.1970	3.759	11.3618	61	0.3170	4.363	8.0622
68	0.3170	4.254	9.7176	38	0.5320	2.433	4.1981
56	0.2520	3.385	23.5859	41	0.9830	6.099	19.3385
138	0.7040	3.483	9.6814	41	0.6210	2.925	13.3937
97	0.1850	5.640	11.4281	16	0.3820	1.012	7.3338
55	0.0780	14.909	31.6598	17	0.7590	4.112	9.1768
140	0.7070	3.082	10.6659	88	0.3510	3.302	18.2942
17	0.6230	1.314	7.6033	69	0.2950	2.475	7.6837
149	0.1710	5.415	12.0438	54	0.8330	4.359	20.5332
61	0.3970	2.162	7.5535	60	0.3360	5.074	6.5941
38	0.6850	3.272	7.1549	30	0.4530	4.484	8.2625

The Fig. 6 shows a detail of the first 20 harmonics to establish the output quality. The fundamental harmonic is 76.7%.

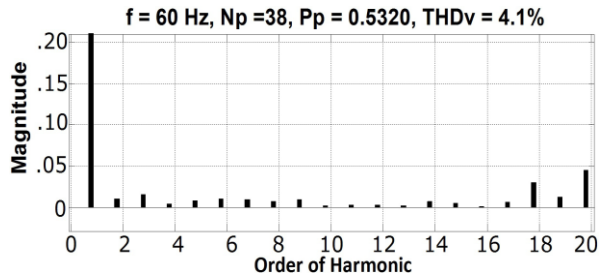

Fig. 6. Harmonic spectrum (60 Hz), first 20 harmonics. Source: Authors

2.12 Particles Swarm Optimization

Particles Swarm Optimization (PSO) is inspired by the movements made by swarms; all individuals in the cluster or swarm communicate with each other [10]. In the written code the particles correspond to the set the pulse position (Pp) and pulse number (Np), then running the test of all particles are selected for which the best result, and is set as a destination for others this combination of parameters Np and Pp.

This algorithm uses a parameter called φ (ratio for learning (weights) that control the cognitive and social components, which represent the distance between the current position and the best known of the particle as well as the best position in the neighborhood, respectively); this value will indicate the percentage change in Pp and Np of each particle relative to the error of the best combinations until the moment of each interaction [11]. Fig. 7 shows the flowchart of the particles swarm optimization algorithm used.

2.13 Particles simulation

Firstly, the simulation parameters such as: φ , frequency and particles number, are configured. After the simulation the result (Np and Pp combination) is stored.

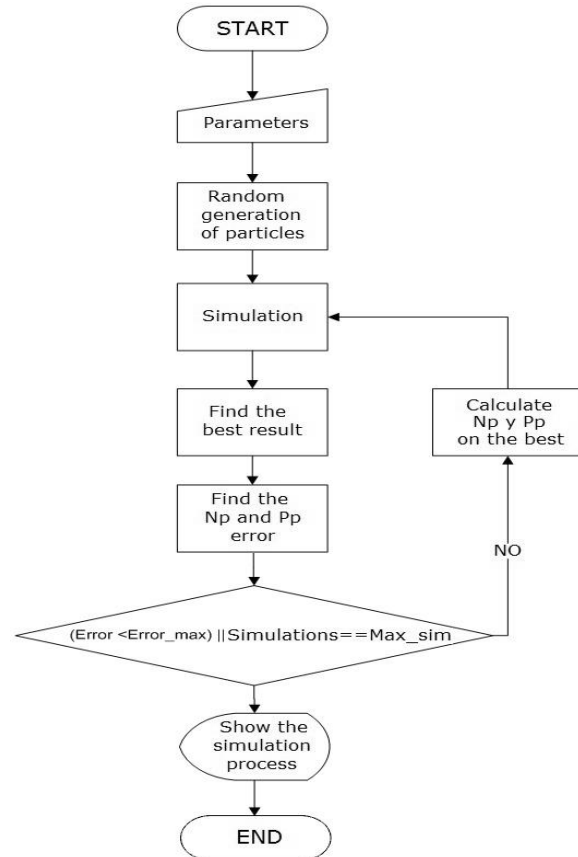

Fig. 7. PSO algorithm flowchart. Source: Authors

2.14 Best result

For the choice of the best particle, the one having the lowest value of the 5th and 7th harmonics is selected, with respect to the combination of Pp and Np of the particle is determine the error of each of the other particles in the cluster. The algorithm stops when the sum of $error_{pp}$ and $error_{np}$ is less than 0.5%, assuming it has not found a better result. The speed with which error reduces is given by the φ factor, and it is defined as: $0 < \varphi < 1$, this value is chosen depending on the search.

2.15 Calculation of Np and Pp

Once the error of the position and the number of pulses is calculated, the new values of pulse position and pulse number (P_{pp} , N_{pp}) are given by the following relations, (2) and (3):

$$Ppp = Ppp + (error_Pp * \varphi * rand) \quad (2)$$

$$Npp = fix(Npp + (error_Np * \varphi * rand)) \quad (3)$$

φ es the ratio for learning (weights) that control the cognitive and social components, rand is a random number [0-1]. The fix function rounds the value of the pulse number (Npp) to an integer number.

2.16 Particle Swarm Optimization results

The randomly generated particles are evaluated and the one with the best feature becomes the destination of the other particles; if during the course a local solution is better than the current global solution, this becomes the destination. Table 4 shows the particles generated randomly at the beginning of the simulation and the results.

Table 4. Random particle generation. Source: Authors

Number of pulses	Pulse position	% 5 th y 7 th harmonics	%THDv 20 harmonics
163	0.905	14.7976996	87.9688236
26	0.913	5.80180199	16.3169998
127	0.097	5.44970291	18.2788112
56	0.546	6.99930667	21.5030011
192	0.964	7.30016292	18.0633703
32	0.97	4.9511462	25.0492748
192	0.485	4.83733771	8.71673143
161	0.141	5.50887574	80.2616564
85	0.915	4.10385292	34.1374036
159	0.959	3.79133806	90.7425619
132	0.035	5.91397322	22.5845866
170	0.933	15.3428578	89.9975794
136	0.757	1.96631442	9.84232999
179	0.515	0.58342348	4.82389321
132	0.171	7.79048761	13.974641

The speed with which other particles converge toward the target point is determined by the gravity factor. After completing the process all the particles find together in the best solution found, the convergence point is Np=179 and Pp=0.515, the fundamental harmonic magnitude is

77.3%, THDv=4.82% and sum of the 5th and 7th harmonics magnitudes are 0.58%. Fig. 8 shows the signal harmonics spectrum for 60 Hz and Fig. 9 shows the path of particles in the search for the best solution.

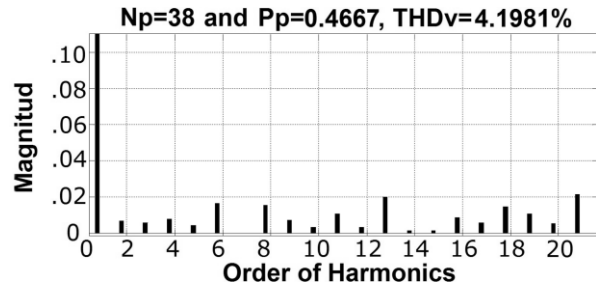

Fig. 8. Harmonic spectrum (60 Hz), first 20 harmonics. Source: Authors

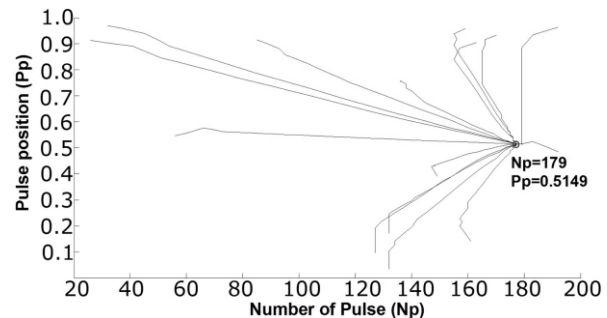

Fig. 9. Path of the particles swarm. Source: Authors

2.17 Ant Colony Optimization

The method of ant colony optimization (ACO) is inspired by the behavior of real ants in finding paths from the colony to the food. The route is taken as an optimization parameter Pp. The number of routes is a parameter that is entered at the beginning of the simulation, another if pheromone (0.001 starting on all routes). Routes with less THD increase the pheromone and with high THD decrease the pheromone [12]. Overall, the *Kth* parameter moves from state *x* to state *y* with probability:

$$P^{kxy} = (\tau_{xy})^\alpha \cdot (\eta_{xy})^\beta / \sum (\tau_{xy})^\alpha \cdot (\eta_{xy})^\beta \quad (4)$$

Where, α and β are parameters that determine the importance of the pheromone and heuristic information, respectively, τ_{xy} is the amount of pheromone will be depos-

ited in the transition from state x to y , and η_{xy} is the transition state convenience xy . The value of the pheromone $\tau(x,y)$ at point (x, y) after the update of values is given by

$$\tau(x,y) = (1-\rho) \cdot \tau(x,y) + \sum \Delta_i \tag{5}$$

ρ is the evaporation factor, $\tau(x,y)$ is the value of a pheromone from the point (x,y) , and Δ_i is the ratio of variation in the pheromones.

2.18 Ant Colony Optimization results

In Fig. 10a each one of the parallel lines to the abscissa axis are the routes in the simulation, the established routes value is 30. The Fig. 10b was obtained as a result of the implementation of the ACO algorithm, which represents the harmonic spectrum for the PWM signal with $N_p=38$ and $P_p=0.4667$, the sum of 5th and 7th harmonics is 1.987% and the THD_v is 4.1981%. The harmonic spectrum is up to 20th harmonic. Table 5 comprises the best optimization results for each bio-inspired methods used.

3. ANALYSIS

From the results of Table 5 we excluded the Tabu Search as solution; cause does not meet the harmonic distortion regulations (IEEE-519) which requires a THD_v

contribution less than 5%. The best results are achieved to the extent that the pulse position is located near the middle position ($P_p=0.5$) or symmetry of the pulse. Into the others three methods the chosen result is by the ACO method based on the lowest THD_v content and less 5th and 7th harmonics magnitude with fewer pulses ($N_p=38$), almost 5 times lower than the result of PSO ($N_p=179$). We achieved considerable inferior inverter losses lowering the switching frequency (4560 Hz) of the power devices [13].

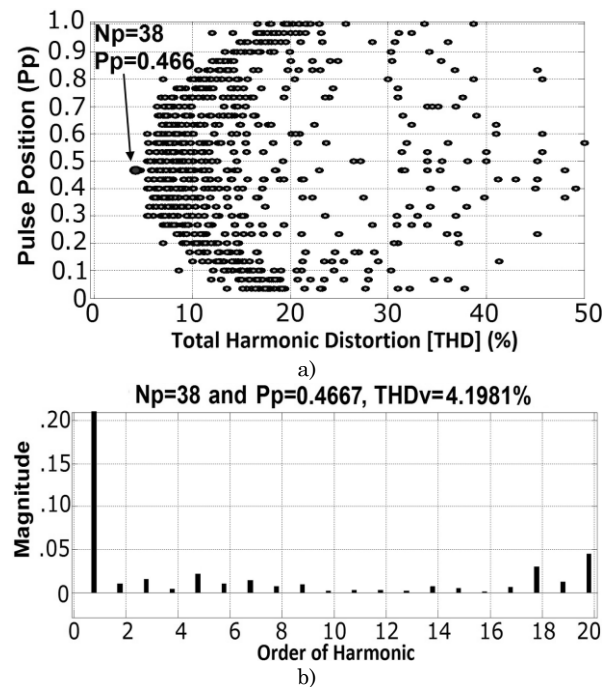

Fig. 10. Results for ant colony optimization. a) Routes, b) Harmonic spectrum (60 Hz). Source: Authors

Table 5. Best optimization results by methods. Source: Authors

Optimization Methods	N_p	P_p	%5 th y 7 th harmonics	%THD _v 20 harmonics	Switching frequency [Hz]
Tabu Search	30	0.308	1.281	5.7638	3600
Genetic Algorithm	38	0.532	2.433	4.1981	4560
Swarm Particle	179	0.515	0.580	4.8200	21480
Ant Colony	38	0.467	1.987	4.1981	4560

4. CONCLUSIONS

Using bioinspired optimization methods can be an advantage in terms of reducing search time, because only relying on a system model and knowing the process satisfactory, results are obtained without the need of demanding mathematical analysis throughout the process generating systems of equations of higher order and difficult to solve.

Genetic algorithms successfully optimize the input parameters of the PWM, the results represent a good performance of the algorithm crossover, mutation, reproduction, though not all new individuals "children" have the same or better features than the "parents" does, these unwanted parameter combinations are discarded in the process of selecting the best individuals.

Table 5 (best optimization results by methods) shows the research results quantitatively. It is considered as the best optimization method the one who obtains the minimum value of THD, in this case is achieved by the method of ACO. As for the convergence rate of the algorithms and other performance indicators are not considered significant because the optimization method is performed "off-line" and then is saved in EEPROM or FLASH memory in a microprocessor based system to run in real time. Regarding the accuracy of the results of all methods are constants and 4 digits.

The tabu search unlike other optimization techniques takes advantage of the best combinations found at the time of code execution, nor affected the behavior of other combinations, simply verifying that generates new parameters are not in the history of parameters tested. As for the global search does not have the best performance by not having a level of error analysis or feedback. But it is important to optimize locally because it looks in the neighborhood of the best combinations found.

The algorithms developed can be easily adapted to any minimization problem, only to be changes in the number of variables and selection (or elimination) criteria to obtain good results in complex problems may add conditions or restrictions on the variables to be most stringent assessment criteria.

5. REFERENCES

- [1] N. Mohan, T. M. Undeland, and W. P. Robbins, *Power Electronics: Converters, Applications, and Design*. Wiley John & Sons, 2003, p. 824.
- [2] C. A. Coello Coello, "A Comprehensive Survey of Evolutionary-Based Multiobjective Optimization Techniques," *Knowl. Inf. Syst.*, vol. 1, no. 3, pp. 269-308, Jul. 2013.
- [3] K. L. Shi and H. Li, "Optimized PWM Strategy Based on Genetic Algorithms," *IEEE Trans. Ind. Electron.*, vol. 52, no. 5, pp. 1458-1461, Oct. 2005.
- [4] B. J. Rabi, "Minimization of Harmonics in PWM Inverters Based on Genetic Algorithms," *J. Appl. Sci.*, vol. 6, no. 9, pp. 2056-2059, Sep. 2006.
- [5] S. Sujitjorn, T. Kulworawanichpong, D. Puangdownreong, and K. Areerak, "Adaptive Tabu Search and Applications in Engineering Design," *Integr. Intell. Syst. Eng. Des.*, vol. 149, pp. 233-257, 2006.
- [6] A. H. Wright, "Genetic Algorithms for Real Parameter Optimization," in *Foundations of Genetic Algorithms*, G. J. E. Rawlins, Ed. San Mateo, CA: Morgan Kaufmann, 1991, pp. 205-218.
- [7] A. F. Lizcano, J. L. Díaz, and A. Pardo, "Minimización de la distorsión armónica de una modulación PWM con algoritmos genéticos," *Rev. ITECKNE*, vol. 8, no. 1, pp. 79-86, 2011.
- [8] J. A. Araque, J. L. Díaz, and O. E. Gualdrón, "Optimización del THD en un convertidor multinivel monofásico usando algoritmos genéticos," *Rev. Colomb. Tecnol. Av.*, vol. 1, no. 21, pp. 60-66, 2013.
- [9] J. A. Araque, J. L. Díaz, and O. E. Gualdrón, "Optimization of the THD in a Multilevel Single-Phase Converter using Genetic Algorithms," in *15th International Conference on Automatic Control, Modelling & Simulation (ACMOS '13)*, 2013, pp. 326-331.
- [10] R. N. Ray, D. Chatterjee, and S. K. Goswami, "An application of PSO technique for harmonic elimination in a PWM inverter," *Appl. Soft Comput.*, vol. 9, no. 4, pp. 1315-1320, Sep. 2009.
- [11] M. Dorigo, V. Maniezzo, and A. Colnari, "Ant system: optimization by a colony of cooperating

- agents,” *IEEE Trans. Syst. man, Cybern. Part B, Cybern.*, vol. 26, no. 1, pp. 29-41, Jan. 1996.
- [12] J. A. Araque Gallardo, J. L. Diaz Rodriguez, and A. P. Garcia, “THD optimization of a single phase cascaded multilevel converter using PSO technique,” in *2013 Workshop on Power Electronics and Power Quality Applications (PEPQA)*, 2013, pp. 1-6.
- [13] S. K. Pattnaik and K. K. Mahapatra, “Power Loss Estimation for PWM and Soft-switching Inverter using RDCLI,” in *Proceedings of the International Multi Conference of Engineers and Computer Scientists*, 2010.